



Agenda

Prayer / Invocation

Opening Comments

Purpose

Special Presentation

Agency Updates

Calendar Highlights

Closing Comments





Prayer / Invocation





Opening Comments





Purpose

To publicize information on community services and programs provided by a broad range of installation support agencies. Increase awareness on upcoming and key installation events and initiatives to support Readiness of Soldiers, Families and Installation. Achieve the Senior Commander's intent with regards to strategic communications and information flow.

***A well informed community supports Soldier Readiness!**





SLU DATES

20 JUL 2021, 1100-1200

17 AUG 2021, 1100-1200

21 SEP 2021, 1100-1200





Special Presentations





Meritorious Civilian Service Medal



In recognition of his exceptional service and selection as one of the U.S. Army Materiel Command's 2019 Louis Dellamonica Award Winner for Outstanding Personnel of the Year, from January 2019 to December 2019. Mr. Washington's achievements, dedication, and exemplary performance are in keeping with the highest traditions of Government Service and reflect great credit upon himself, the U.S. Army Materiel Command and the Department of the Army.



2ABCT Special Recognition



U.S. ARMY



We would like to send our sincerest thanks to the Armed Services YMCA, American Red Cross Fort Bliss, and USO El Paso for providing the Soldiers of 2ABCT, 1AD the comfort items and hygiene items needed to make it through their Restriction of Movement after their recent deployment. Items donated by these organizations included:

- 500+ Pizzas
- 432 Peanut Butter
- 528 Chicken Salad
- 1000+ Donuts
- 4332 Oatmeal
- 2100 Cereal
- 816 Juice
- 3000 Milk
- 306 Cookies
- 420 Tuna
- 288 Candy
- 2040 Hand Sanitizers
- Utensils
- Stress balls/Frisbees
- 968 Chips





Digital Garrison App

CONNECT WITH YOUR COMMUNITY
Get your installation services and post information on the NEW Digital Garrison app on your smartphone or tablet.

DIGITAL GARRISON
POWERED BY

Download on the or Get it on

MAKE THE CONNECTION

-1-
GET INFO ON THE GO
Get connected with your community by finding information on services, dining, events and more.

-2-
FIND YOUR WAY
Navigate your way around your installation with real time maps, facility location contact info, weather and more.

-3-
FIND DEALS FAST
Check out the hottest deals on brands you love straight from your Exchange.

-4-
SHOP YOUR FAVORITE CATEGORIES
See latest offers on electronics, fashion trends, home goods and more.

Services Hotlines
Deals MILITARY STAR Sweepstakes Reel Time
Events Installation Recreation Dining

DIGITAL GARRISON
POWERED BY

Download on the or Get it on



Digital Garrison

- Download the “Digital Garrison” app from Google Play or Apple App Store.
- Set up an account and ensure Fort Bliss is selected as your installation.

Get your installation services, weather, maps, gate information & more on the NEW Digital Garrison app on your smartphone or tablet.

Stay up to date with what’s going on in your community, with the NEW Digital Garrison app on your smartphone or tablet.

Find great dining options, while on the go, with the NEW Digital Garrison app on your smartphone or tablet.

Looking for gate, facility or service information on your local installation? Check out the NEW Digital Garrison app today!

Download the NEW Digital Garrison app to find great deals on the top brands and products you love.

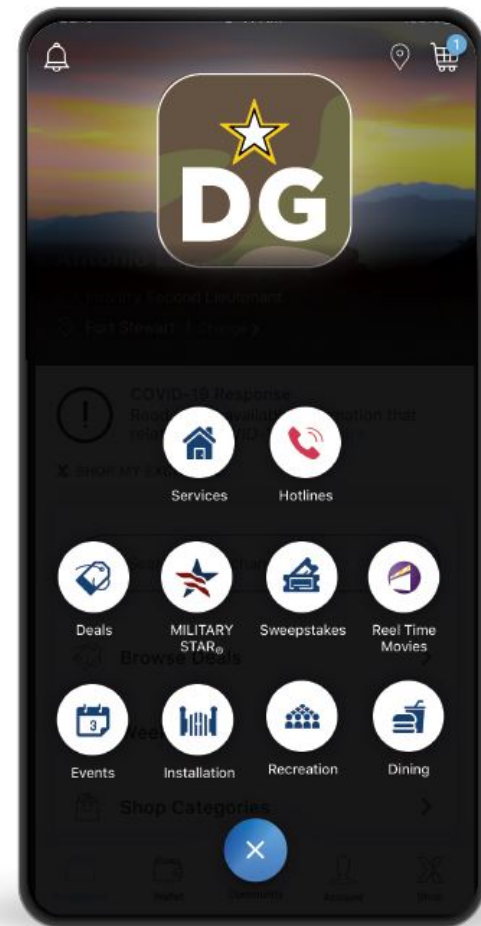

*** NOTE:** Digital Garrison is updated automatically from the Fort Bliss main website





Did you know?

CUI



DISPELLING THE IGNORANCE OF BLISS

Fort Bliss Readiness and Power Projection Comparing Fort Bliss Land Mass to Rhode Island

Army's Largest Divisional Installation / Corps Mission-Sets minus Corps HQ
 Home of America's Tank Division, 1st AD [One of 10 active divisions in the Army]
 Largest, most complex AP3 in the Army & Largest Mobilization Force Generation Installation (MFGI) in DoD [FY19: over 72K]

- ~49K - MOB/DeMOB/CRC
- ~23K - Pre Mobilization Exercise Training (PMET)

Home to the DOD's ONLY CONUS Replacement Center (CRC)
 Interagency operations (EPIC, CBP, JTF-N, DHS elements)
 Support to Multinational Training (Japanese, German)
 Three complete Major Range Complexes (82 Ranges)
 Trained ~23K Rotational Soldiers in FY19
 4 Base Camps (9K PAX) and 9 LSA (45K PAX)
 Ability to fire any weapon (pistol to missile)
 Control Land, Air, and Spectrum

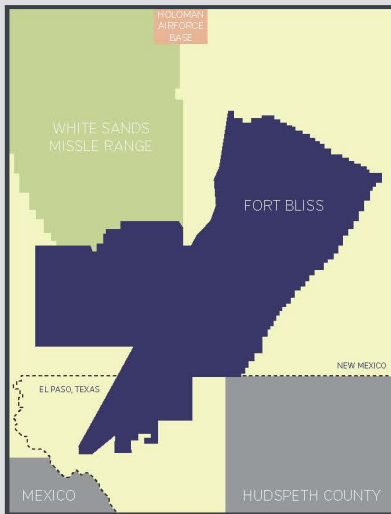

THE STATE of RHODE ISLAND

[776,960 ACRES
1214 SQUARE MILES]

FORT BLISS

[1.12 MILLION ACRES
1,760 SQUARE MILES]

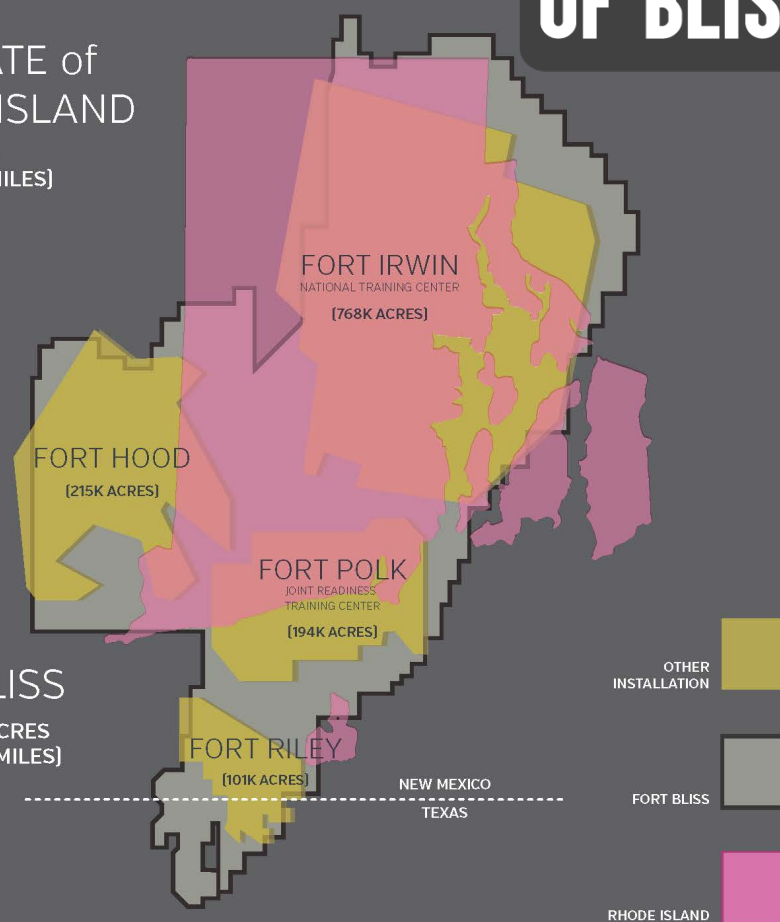

Fort Bliss is bigger than the **WHOLE** state of Rhode Island!





Did you know?



**DISPELLING
THE IGNORANCE
OF BLISS**

**Have you seen these white vehicles
around Fort Bliss?**



**These are Mobilization and Deployment (MaD)
vehicles. The number is that vehicle's identifier.
The 'S' means staff or 'C' means contractor.**





Did you know?



MWR Biggs Park is a 26 acre park!

Some of the amenities include:

- Tennis and Basketball courts
- Softball fields
- Pavilions
- Splash Park opening late summer 2021 🙌
- Equipment Rental
- Table and Chair rentals
- Alpha Warrior Course
- Inflatables rentals
- Home to events in excess of 20K patrons like Pop Goes the Fort
- Available for BDE/BDE/Unit Org Days
- Location of the annual BOSS Bash

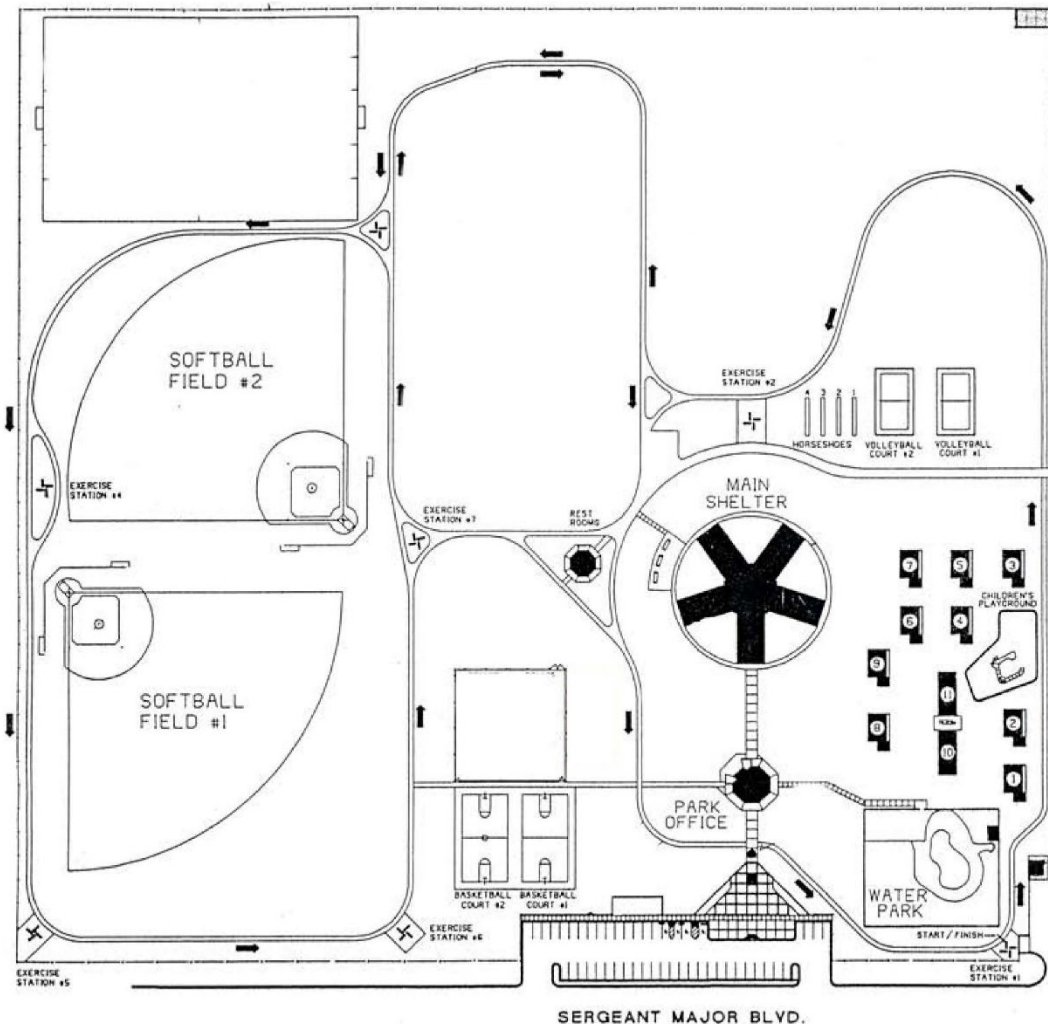

Welcome to Biggs Park!





Did you know?

Expired vehicle registration sticker?



**DISPELLING
THE IGNORANCE
OF BLISS**



**MWR Auto Crafts offers inspection services!
The cost depends on the year of your vehicle
but never exceeds \$18.50.**





Agency Updates





ACS





2021 Army Emergency Relief Campaign



✓ **ARMY EMERGENCY RELIEF CAMPAIGN**
1 March 2021 – 15 June 2021

Current Status:
\$ 86,087.00 as of 07 June 2021

Fort Bliss Goal: \$110,000.00





Army Emergency Relief Online Portal

CUI

Fort Bliss Army Emergency Relief (AER) Portal Pilot Program

✓ **Purpose:** Fort Bliss AER is one of few locations piloting the new Online Assistance Portal. This portal allows Soldiers to:

- Apply for AER assistance
- View the status of your application
- View current loans/grants
- Submit a request or inquiry
- Donate to the AER Campaign



✓ **On-Line Portal:** <https://aerprod.powerappsportals.us/>

✓ **For any questions contact the Fort Bliss AER Office;** Phone 915-568-4706





CYS



School Liaison Office (SLO)



SLO

Bldg. 505 Pershing Road
915-569-5064

Visit us on Facebook

<https://www.facebook.com/Fort-Bliss-School-Liaison-Office-1207712606042078>

Superintendent Profile: The El Paso Independent School District Board seeks the input of school personnel and the public in developing a profile of the leadership qualities desired of the person the Board should seek to become the new superintendent.

Access the survey at: <https://surveys.tasb.org/s3/El-Paso-isd-Leadership-Survey-2021>

EPISD Focus Group: Address the needs of military connected students as they transition out of COVID protocols to face-to-face instruction. Primary topics included:

- Proactive engagement; intentional use of resources
- Augment staff
- Staff professional development
- Address learning, social, and emotional needs
- Reengage extra curricular activities: sports, fine arts, JROTC
- Transition issues compounded by COVID and social isolation
- Virtual resources
- Closing learning gaps; summer enrichment programs and remediation
- Special education population

HB 1468: Without the passage of HB 1468, remote/hybrid learning is not authorized for full funding within existing frameworks for school year 2021-22



Army Continuing Education System (ACES)



The Army Continuing Education System (ACES) mission is to promote lifelong learning, readiness, and resilience through flexible and relevant education programs, services, and systems.

- Provide Soldiers, Family Members, and Civilians services and information on:
- Education and Career Counseling
 - Testing, Assessment, and Evaluation Services
 - Leadership Development
 - Tuition Assistance
 - Career Management
 - Transition Assistance
 - Basic Skills Education Program
 - Credentialing Assistance
 - Unit and command briefings

ACES
 Bldg. 2916/2917 Carrington
 Road
 915-568-6792/6828/6776

Visit us on Facebook

<https://www.facebook.com/fortblisseducationcenter/>

Sunset of College and Career Readiness Exams Reimbursement Program which includes GED, GRE, GMAT, ACT, SAT, and the Praxis Series

Reimbursements must be submitted NLT 30 June. ACES counselors are here to help.





MWR





Family and MWR

Events

Date	Time	Event	Location	Comments
26 JUN 21	1100	Aquapalooza Summer Kick-Off Water Event	Biggs Park	Free
1 JUL 21		Registration for Cardboard Regatta begins	bliss.armymwr.com Search: Cardboard	FREE
4 JUL 21	1600	Pop Goes the Fort El Paso Symphony Orchestra/Fireworks	Biggs Park	TBD
23 JUL 21	1800	Lucha Libre- Mexican Masked Wrestling	TBD	FREE
24 JUL 21	0730	Army Ten Miler Qualifier	Soto PFC	
14 AUG 21	1300	Cardboard Regatta Boat Race	Community Pool	FREE

www.bliss.armymwr.com





Community Events

El Paso

Date	Time	Event	Location	Comment
THURSDAYS	1800	Cool Canyon Nights-Concerts	McKelligon Canyon	Free
23 JUN 21	2000	ZZ Top	Abraham Chavez	\$47/up
2 JUL 21	2000	Viva El Paso Opening Night	Mckelligon Canyon	TBD
11 JUL 21	2000	INTOCABLE-Spanish Band	Plaza Theater	\$37.49
18 JUL 21	1100	Mission Trail Art Market	San Elizario	Free
22 JUL 21	2000	Divas	Plaza Theater	\$50/up

www.visitelpaso.com



Pop Goes the Fort



★ *Fireworks Spectacular by:* **USAA**[®]

Pop Goes the Fort

10TH Anniversary

★ ★ ★ *Featuring* **EPSO**
 THE EL PASO SYMPHONY ORCHESTRA

SUNDAY, JULY 4
 BIGGS PARK • 11388 SERGEANT MAJOR BLVD.

Gates Open at 4pm
 1st Armored Division Band at 5:30pm
 El Paso Symphony Orchestra at 7:30pm
 • Fireworks Immediately Following Performance •

NO OUTSIDE ALCOHOLIC BEVERAGES, GLASS CONTAINERS OR PETS ALLOWED. | **ATM** AVAILABLE INSIDE PARK

Info: 915-588-8247 or bliss.armymwr.com
 No official U.S. Army endorsement is implied.

Final details concerning capacity limits, tickets, and mask/vaccination requirements will be released on Friday, June 18 via the MWR Facebook page. We apologize for the delay. Hope to see you at the park on July 4th!





WBAMC





WBAMC Updates MAY 2021

CUI

✓ COVID-19 Vaccine Efforts as of 14 June 2021:

- Administered: 60,808 doses
 - Three (3) COVID-19 Vaccination Efforts
 - Freedom Crossing **For Walk-Ins:** 1000-1330 (Next to Military Clothing and Sales)
 - Stout Gym **Appointment based** via TRICARE ONLINE or Appointment Line 915-742-2273
 - Mobile Vaccination Teams For Ft. Bliss Units and New Comer's Orientation (Thursdays @ Stayton Theater)
 - All eligible beneficiary \geq 12 years of age, Service Members, DoD Civilian Employees, and DoD Contractors Employees
 - Individuals must present a current DoD ID or Ft. Bliss issued badge

✓ New Hospital Transition

- **Facebook Live Town Hall:** **8 JULY 2021 @ 1800 (Tentatively)**
- **First Patient Date:** **11 JULY 2021**
- Safety for patients and staff is our priority
 - Delays are due to safety and compliance standards
 - Actively evaluating and working concerns with appropriate parties

✓ Visitor Policy Updates

- Now allow **one (1) visitor** and/or escort per patient at any given time
- **Patients at risk for imminent death (within 24 hours):** Allowed up to four (4) visitors at any given time.
- **Laboring or Post-Partum Patients:** Parent or legal guardian may bring newborns and infants (18 months or younger) to an appointment if necessary
- **Face Covering/Mask Required:** Patients and visitors should wear their own well-fitting form of source control (face mask) upon arrival to and throughout their stay in the facility. Face masks should not be placed on children under age 2 years, anyone who cannot wear one safely, or anyone who is unconscious or is incapacitated



Vaccination Updates



What Vaccine is Available?

1. We are **currently administering the Pfizer-Biotech** COVID-19 vaccine to all eligible beneficiaries (ages 12 years and older), DoD Civilians, and DoD Contractors.
2. The Moderna vaccine is currently designated to support 2nd dose vaccinations for mobilizing individuals who received their first dose at their home station prior to arriving at Fort Bliss.
3. The Johnson & Johnson (Janssen) COVID-19 vaccine is not available at the moment. This is currently reserved the DoD is planned to be utilized in our austere locations for deployed and shipboard forces.

Visit the [Centers for Disease Control and Prevention](#) to learn more about the COVID-19 vaccine.

- [Getting the COVID-19 Vaccine](#)
- [COVID-19 Vaccine for Adults Age 75 and Older](#)
- [COVID-19 Vaccine Trials](#)
- [CDC U.S. COVID-19 Vaccine Product Information](#)

Additional Resources:

Effective April 19, 2021 all eligible and authorized TRICARE beneficiaries can make a COVID-19 vaccine appointment, as available, at a [DOD vaccination site](#) [Opens to page on TRICARE.mil](#). The Department's priorities are:

- Protecting our Service members, DOD civilians, and families
 - Safeguarding our national security capabilities
 - Supporting the whole-of-nation response to the COVID-19 pandemic
- [TRICARE Beneficiary Information](#)



Vaccination Updates

CUI



Vaccine Location by Age Group

Ages 12-17 years old: Appointment Only

Please make an **appointment** to receive your vaccine **at Stout Gym**. The Freedom Crossing vaccination site cannot accommodate this age group due to staffing limitations. A parent or legal guardian is required to be present at the site to provide consent for vaccination.

Ages 18 years and older: Appointment or Walk-in

For individuals age 18 year older, you may make an appointment to receive your vaccine at Stout Gym. **Walk-ins** are accepted **at the Freedom Crossing** vaccination site located next to Military Clothing Sales.

What to bring to receive my vaccine?

1. Military ID Card
2. Employment ID (for DoD Civilians and Contractors)
3. Vaccination Card
4. DHA Form 207 – May 2021 version
5. DD Form 2870

Vaccination Sites and Hours

COVID-19 vaccinations are available through appointment based or walk-ins as indicated at the following locations:

BY APPOINTMENT → STOUT GYM:

2930 Cassidy Rd Fort Bliss, TX
79916

M-F 0900-1500

SAT 0900-1300

Closed on Sundays and Federal Holidays.

*** Appointments are required for individuals 12-17 years old**

BY WALK-IN → FREEDOM CROSSING

Located next to Military Clothing Sales

TUES- SAT 1000-1330

Closed Sunday, Mondays, and Federal Holidays

*** Walk-ins available for ages 18 years or older only**



Vaccination Updates

CUI



How to Schedule an Appointment?

ONLINE or TELEPHONE

ONLINE: TRICARE beneficiaries can visit the TRICARE Patient Portal (TOL) at www.tricareonline.com to book an appointment online. Click on the following link to view/download detailed instructions on how to book your appointment online also found on the WBAMC COVID-19 vaccination webpage:

<https://william-beaumont.tricare.mil/Getting-Care/COVID-19/COVID-19-Vaccinations>

TELEPHONE: TRICARE beneficiaries who do not have access to TOL can call the appointment line at 915-742-2273 to schedule COVID-19 vaccine appointments.

If I received my vaccination Off-Post

If you received your vaccination **OFF-POST**, please submit the following documents to have your electronic medical record updated:

1. **Proof of Vaccination**
(ie vaccination card)
2. **DD Form 2870** (Authorization For Disclosure of Medical or Dental Information) – Completed & signed
**This is also required for ALL GS, contractors, and volunteers so that APHN can enter the information into MEDPROS and AHLTA.*
3. **Drop off** copy of Proof of Vaccination and Completed DD Form 2870 at **STOUT GYM** during operating hours

Please ensure your proof of vaccination includes the following information:

- Manufacturer*
- Lot number*
- Dose*
- Route*
- Injection site*
- Date the vaccine was given*
- Signature of the person that administered the vaccine*
- Date the Vaccine Information Statement was reviewed (VIS)*





William Beaumont Army Medical Center

Delivering Quality Healthcare to Soldiers and Beneficiaries to Sustain a Ready Force



Early years (1849–1892)
From its beginnings in 1849, the medical units that supported the Army installation in El Paso have moved several times. In January 1854, "The Post of El Paso del Norte", was established on Magoffin's Ranch. Remains of the original Army Hospital located at Hart's Mill were uncovered by archaeologists in 2012 near the main campus of University of Texas At El Paso.

Formative years (1893–1898)
The 1890s saw the establishment of a permanent hospital at Fort Bliss in support of a permanent regimental post along the border. This building, now known as Building 8, is currently the location of the Fort Bliss Inspector General's Office.

Spanish–American War (1898–1902)
During this period, the hospital supported a skeletal garrison at Fort Bliss, containing never more than 100 Soldiers. By 1902 the hospital, along with all the buildings on Fort Bliss, had fallen into disrepair.

Civil War – under control of Confederate Army (1861–1862)
Fort Bliss and the hospital remained Confederate until 20 Aug 1862. The retreating Confederate troops destroyed all of Fort Bliss, except for the hospital, which housed their sick and wounded.



18511 Highlander Medics St
Fort Bliss, TX 79918

New Fort Bliss Post Hospital (1903–1919)

The new Post Hospital building was completed in 1904. The first Army dental training school was established at the Fort Bliss Post Hospital in September 1916 by Captain Robert T. Oliver.

World War II and after (1940–1968)

William Beaumont General Hospital served as one of many prisoner-of-war hospitals across the United States that supported the prisoner-of-war camps at Fort Bliss and surrounding camps during World War II. During early 1945, approximately 6,000 inpatients were treated.

William Beaumont Army Medical Center (1969–March 2021)

In 1969, the Army began construction of a new, 12-story hospital to the west of the WBGH area. Completed in 1972, the new facility became known as the William Beaumont Army Medical Center. Although originally designed for 611 beds, the hospital had a bed capacity for more than 150 patients; during contingencies, the hospital could expand for 373 patients. As the Southwest's major regional Army medical center, this facility provided medical care to active and retired military personnel and their dependents as well as Veteran beneficiaries in the three-state region of Texas, New Mexico, and Arizona.





Hospital Tower

West Clinic

East Clinic

Admin



Emergency Services

The Emergency Department is located on the **1st floor of the Hospital Tower.**

The main entry to the Emergency Department is located at the southwest portion of the facility with the following accommodations:

- Ambulance/EMS Drop-Off Bay
- Patient Drop-Off Bay
- 4 Trauma Bays
- 36 Emergency Exam Rooms
- Co-located to Radiology Services
- Co-located to Chaplain Services

Hospital Tower

Hospital services are located in the Hospital Tower. The 7-story tower will contain:

- 10 Operating Rooms
- 135 patient beds to include the following:
 - 16 Intensive care (ICU)
 - 48 Medical & Surgical
 - 16 Labor & Delivery
 - 24 Mother & Baby
 - 23 Behavioral Health
 - 8 Post Anesthesia Care

Amenities

Patients, visitors, and staff will have access to these and other amenities throughout the facility.

Dining Facility: 1st floor of the Hospital Tower with seating throughout the center entrance.

Dept. of Ministry and Chaplain Services: 1st floor of the Hospital Tower with access to the Exterior Chapel Meditation Garden.

Conference Rooms: Several conference rooms are located throughout the hospital, two of which are also co-located within the Dining Facility seating area.

Outdoor Courtyards: There are several outdoor courtyards located behind the center entrance and between the clinic towers.

AAFES Shoppette: 1st floor Hospital Tower

Grab-n-Go Healthy Options: 1st floor between the West and East Clinics

Outpatient Clinics

The new WBAMC provides 30 Primary & Specialty Care Clinics. Most clinics are located in either the West Clinic or the East Clinic. The Clinic Entrance is located along the east side of the facility along Parking Lot B. Listed below are several of the specialty clinics:

- | | |
|---------------------|---------------|
| Endocrinology | Neurology |
| Cardiology | OB/GYN |
| Dental | Ophthalmology |
| Gastroenterology | Optometry |
| Hematology/Oncology | Orthopedics |
| Internal Medicine | Pulmonology |
| Newborn | Urology |

Ancillary Services

Co-located within the West Clinic are several patient services to include:

- | | |
|-------------------------|---------------------------------------|
| Outpatient Pharmacy | 1 st Floor, West Clinic |
| Lab Specimen Collection | 1 st Floor, West Clinic |
| Radiology Services | 1 st Floor, Hospital Tower |
| Medical Records | 1 st Floor, West Clinic |





William Beaumont Army Medical Center

Delivering Quality Healthcare to Soldiers and Beneficiaries to Sustain a Ready Force

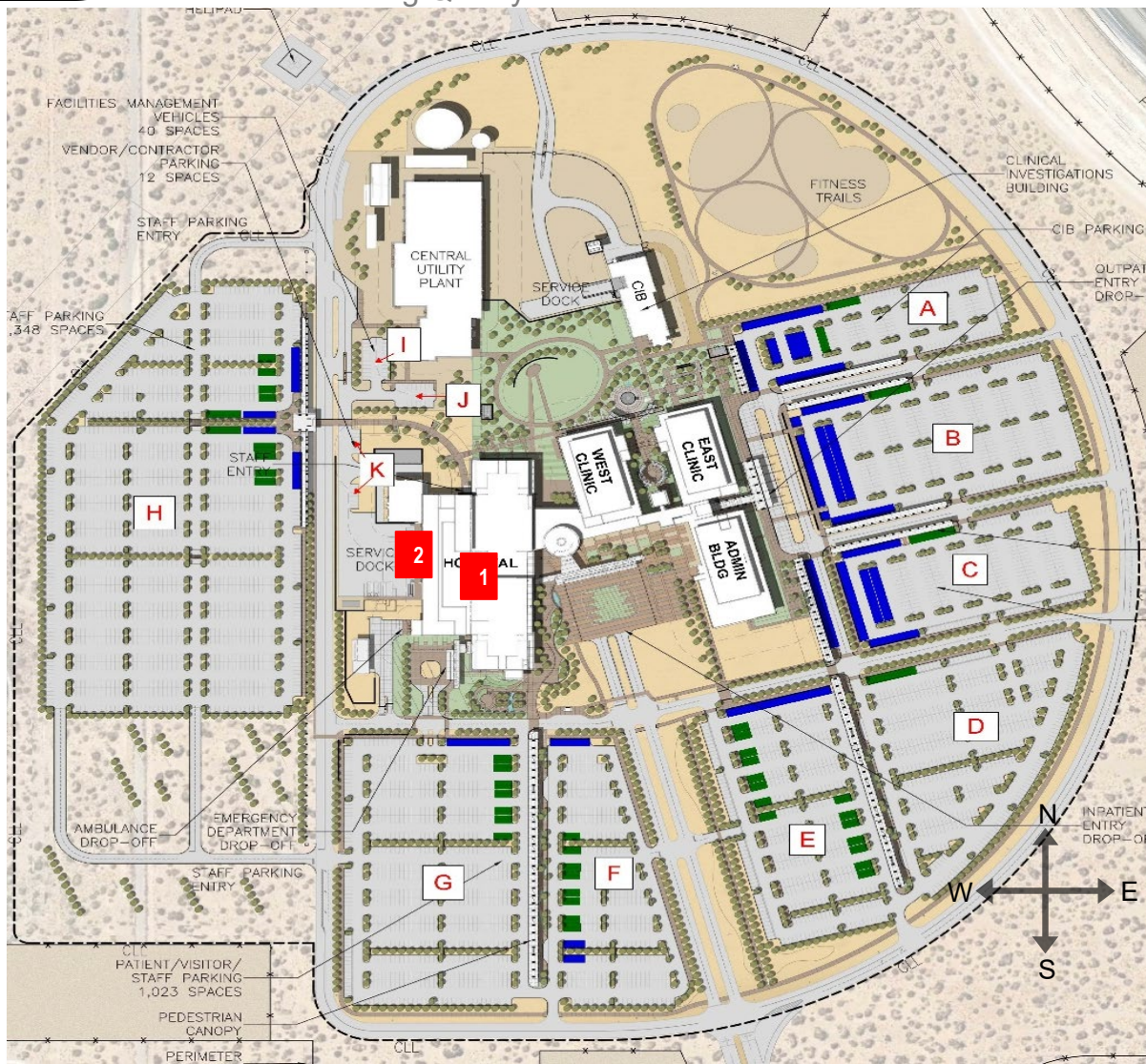

Parking Areas & Access

- A. CIB Parking
- B. Public Parking
- C. Public Parking
- D. Public Parking
- E. Public Parking
- F. Public Parking
- G. Public Parking
- H. Staff Parking
- I. Facility Management

1. Emergency Drop Off
2. Ambulance Drop Off

18511 Highlander Medics St, Fort Bliss, TX 79918





Primary Entrances

- A. Emergency Department
- B. Hospital Main Entrance
- C. Clinic Entrance

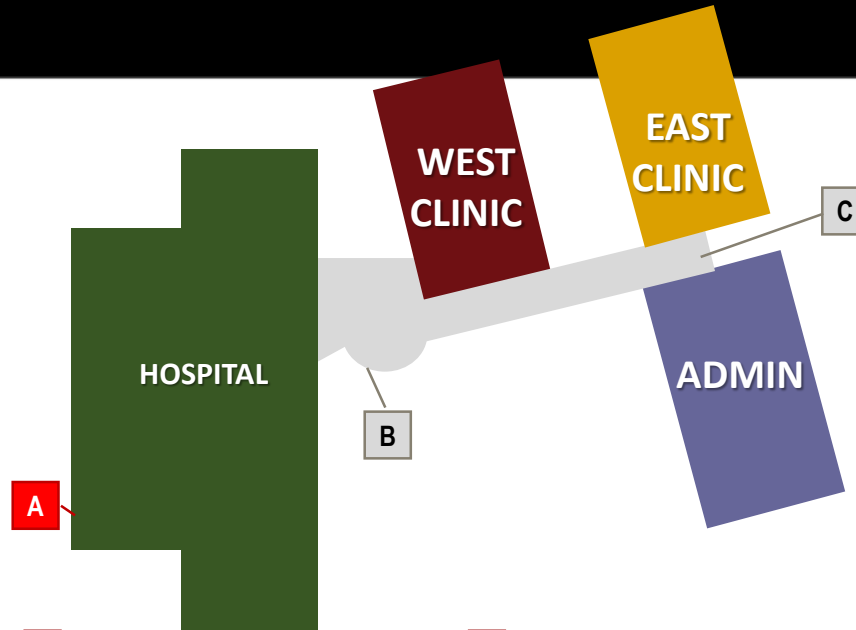
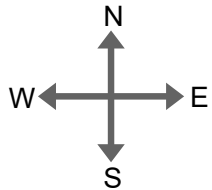

- 1 Assembly Hall
- 1 Badging Station
- 3 Cardiology / Anticoagulation Clinic / CVIR
- 1 Chapel
- 1 Chapel Meditation Garden
- 3 Clinical Support Division
- 3 Command Special Staff
- 3 Command Suite
- 2 Dept. of Medicine
- 3 Dept. of Nursing
- 3 Dept. of Pathology & BSL Laboratory
- 2 Education Division & GME
- 1 **EMERGENCY DEPARTMENT**
- 3 Emergency Operations Center (EOC)
- 4 Endocrinology & Infectious Disease Clinic
- 2 Endoscopy
- 1 Exchange/Retail Store
- B Food Court
- 2 Gastroenterology Clinic

- 2 General Surgery Clinic
- 6 Hematology/Oncology Clinic
- 1 Hospital Lobby
- 3 Human Resources
- 4 Information Management Division
- 3 Inpatient Behavioral Health
- B Inpatient Pharmacy
- 6 Inpatient Support/Clinical
- 7 Intensive Care Unit
- 4 Internal Medicine Clinic
- 5 Labor & Delivery Unit
- 5 Mammography
- 5 Managed Care Division
- 2 Medical Library
- 6 Medical Nursing Unit
- 4 Medic Specialties Clinic
- 5 Mother Baby Unit
- 6 Nephrology Clinic
- 5 Neurology & Neurosurgery Clinic

- 5 Newborn Clinic
- 1 Nuclear Medicine
- 1 Nutrition Care Clinic
- 5 OB/GYN Clinic
- 3 Occupation Health and Industrial Hygiene
- 1 Occupational Therapy
- 1 Operations Readiness Division
- 2 Operative & Anesthesia Services
- 6 Ophthalmology Clinic/WRESP
- 3 Oral Maxillofacial Clinic/General Dentistry
- 3 Orthopedic Clinic
- 4 Otolaryngology, Speech, & Audiology
- 1 Outpatient Pharmacy
- 6 Pain Management Clinic
- 1 Pathology - Outpatient Specimen Collection
- 1 Patient Administration
- 1 Patient Experience
- 1 Physical Therapy
- 2 Plastic and Reconstructive Surgery Clinic

- 2 Post Anesthesia Care Unit
- 1 Preadmission Unit
- 2 Pulmonary Clinic
- 3 Quality Management Division
- 1 Radiology
- 3 Rehabilitation Services
- 4 Resident Support Space
- 1 Resource Management Division
- 7 Sleep Study Lab
- 3 Staff Judge Advocate
- 7 Stepdown Unit
- 2 Surgery
- 6 Surgical Nursing Unit
- 3 Troop Command
- 1 Uniform Business Office
- 2 Urology Clinic
- 5 Vascular Thoracic Surgery Clinic
- 5 Women's Inpatient Support





RSO





Fort Bliss Community Celebration

CUJ



What: First Fort Bliss Community Celebration in honor of the 246th Chaplain Corps Anniversary.

Purpose: Connect Fort Bliss Soldiers, Families, and the newcomers to various religious communities and services to enhance spiritual readiness and resiliency of the entire community

Proponent: 1st Armored Division Chaplain Section

Who: All Fort Bliss Community

When: Friday, 23 1100-1500 JUL 21

Where: Biggs Park

Uniform: Appropriate Civilian Attire

- Free food and Kona Ice for the first 500
- Community resource tables
- Inflatables (water inflatables included, children dress accordingly)
- Gaming truck
- Laser Tag
- Giveaways





DPW





DPW-ED Conservation Branch

What can you do to assist with controlling Feral, Stray or Wild Animals?

Evidence of residents feeding feral cats were observed on Ft Bliss within the Housing Areas. Feral cats, and food provided to feral, stray and wild animals, are attractants and food sources for coyotes and other wild animals.

Please:

- **DO NOT** feed feral, stray, or wild animals.
- **DO NOT** confront, approach, or corner any animals, as they may perceive it as a threat.
- **DO NOT** leave pets, pet food, food scraps, or trash outdoors and available to animals.
- **REPORT** all sightings to the Service Order Desk.
- **REMEMBER** feral cats are prey items for coyotes, attracting them to residential areas.
- For aggressive animals, **ALWAYS** notify first the Ft. Bliss Military Police at (915) 568-2115



To report sightings of feral/wild animals
please call the below number:

DPW Service Order Desk
(915) 642-5477



If you have questions on this issue, please call the DPW-Environmental Division Office, (915) 568-3782.





Cassidy/Sheridan/Pershing Rd. Improvements

On or about December of 2021, a project will begin to permanently block the Sheridan Road cross traffic at Cassidy intersection to improve traffic flow through the Cassidy Gate

- Pedestrian crossing signals will remain at Cassidy/Sheridan
- A new traffic light will be installed at the intersection of Cassidy/Pershing to allow protected left turns on to Cassidy.

 Blocked locations

 New traffic light

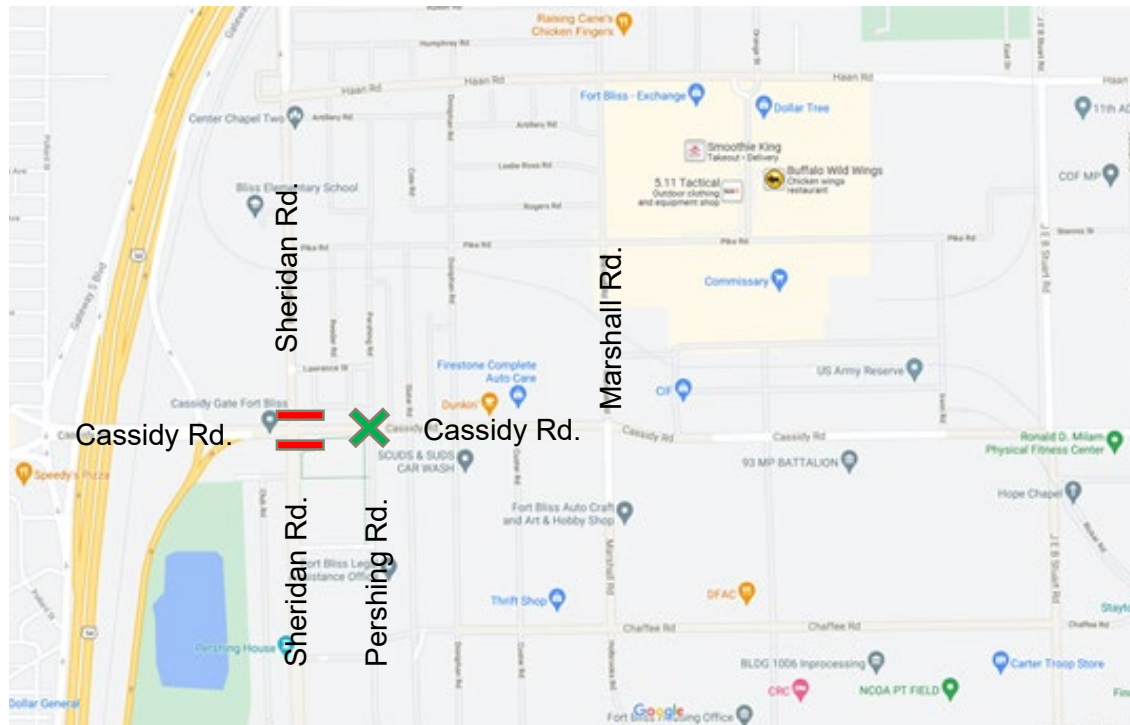



Cassidy Rd. Project East of Marshall Rd.

Guard rail removal project at the location shown below will be completed on 31 Jul 21

- Currently one of the westbound lanes on Cassidy Rd. is closed to traffic





DES





Weapon Registration and Gate Access

SAVE TIME GET OUT OF LINE





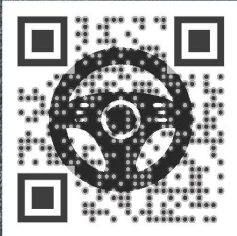

**SCAN HERE TO
REGISTER YOUR
WEAPONS**



**SCAN HERE FOR
GATE INFO AND
PASS APPLICATION**

FOR MORE INFO 915.568.6853







- Minimizes effort from customers.
- Available at various locations throughout Fort Bliss.
- Completely eliminates the need to visit the VCC (Weapons Registration).
- POCs: Mr. Tom Cain, PSI Chief at 744-9146, or Mr. Dary Antonetty, DES OPS at 744-9144.
- **PLEASE SHARE!**

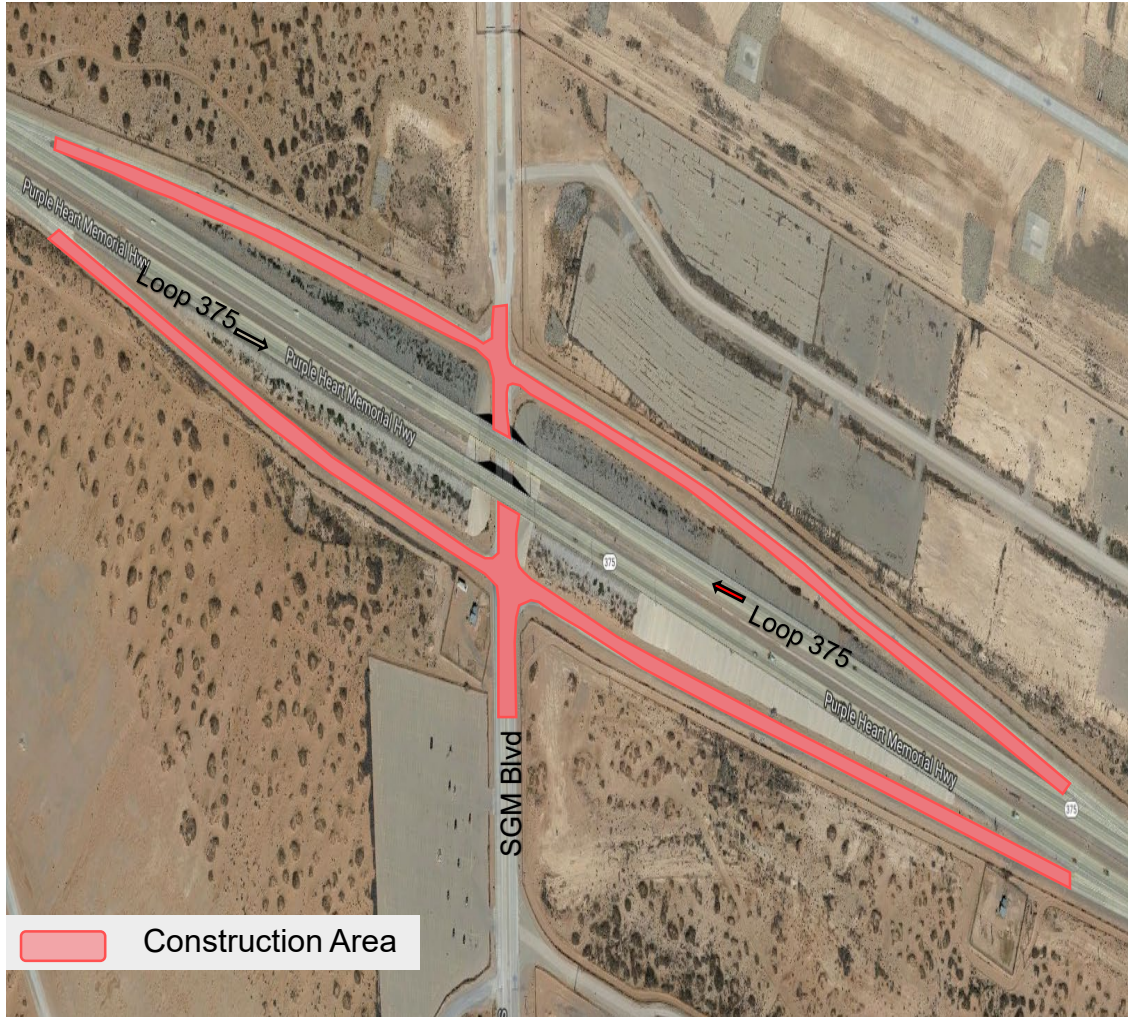

CUI

CSM Barreras (ACP Closure)



- Construction will start o/a **15OCT21** – for a duration of **8-12 months**.
- CSM Barreras ACP (Serves East Bliss) will be closed for the duration of project.
- BMM will be shifted from CSM Barreras to Constitution.
- Constitution ACP and Old Ironsides ACP will serve as main entry points for East Bliss
- Possible high volume given DHHS Support.
- POC Mr. Tom Cain at 744-9146





BOSS





Better Opportunities for Single Soldiers

CUJ



- ✓ **Many Single Soldiers are unaware of the BOSS program, as their units do not have representatives.**
 - Please ensure your units all have a BOSS representative who will brief the Single Soldiers and maintain a board with flyers we provide.
 - As we rebuild the program, we went from having 0 representatives in February 2021, to having 75 currently (including alternates).
 - On May 27th, BOSS gave out 40 Chihuahuas baseball tickets, units without representatives miss out on these types of giveaways.
 - The following slides will show where we are lacking representation:
(3rd Brigade is mobilizing, they should still ensure they get representatives for their Rear-Detachment elements, but primarily focus on networking with the BOSS units in Korea.



III Corps Representation Map

 = Battalions that have at least one BOSS rep within them

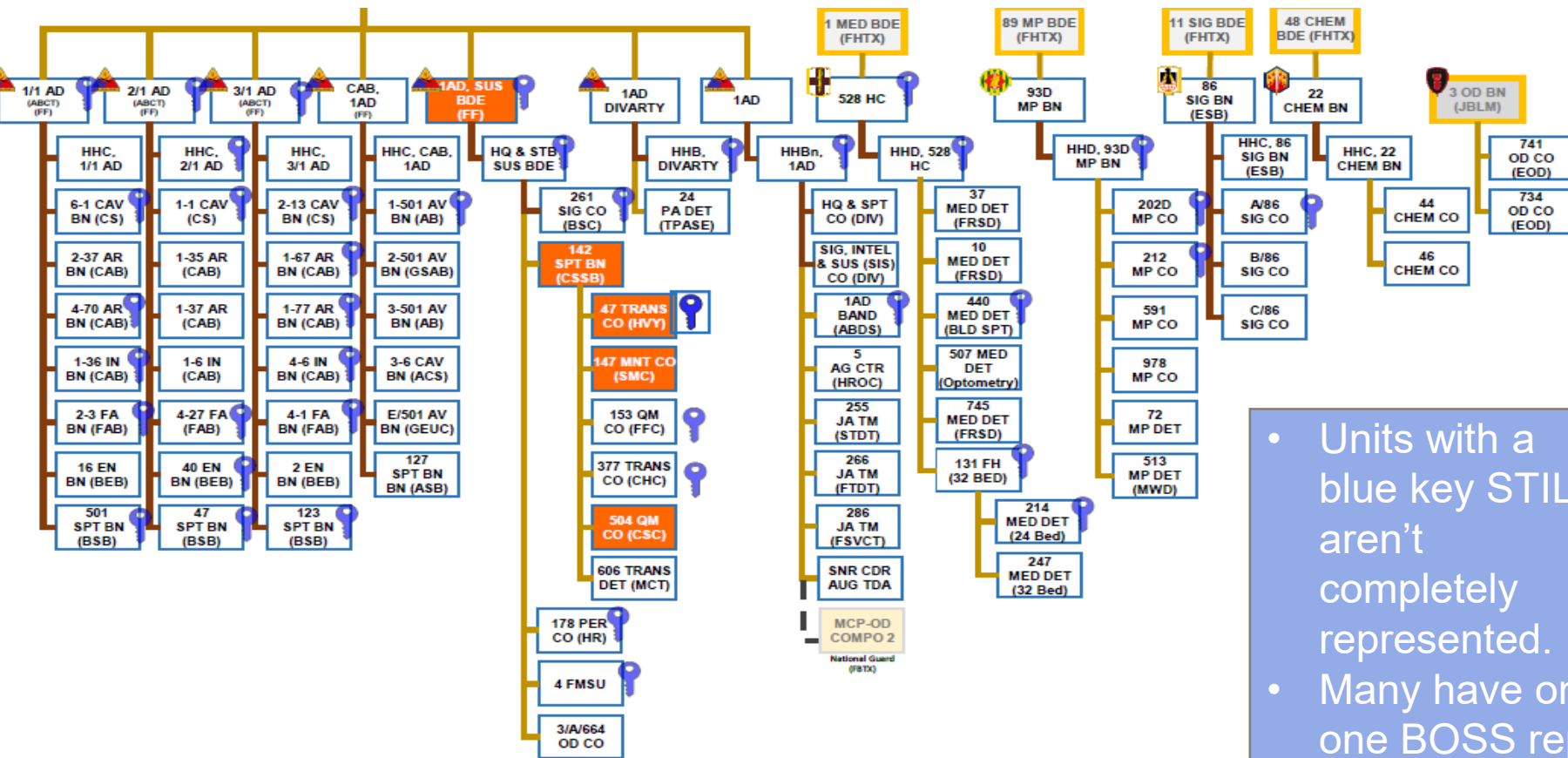

- Units with a blue key STILL aren't completely represented.
- Many have only one BOSS rep for the entire BN.

2-3 FA almost has complete representation, apart from their HHB battery.



Other Units



= Battalions that have at least one BOSS rep within them

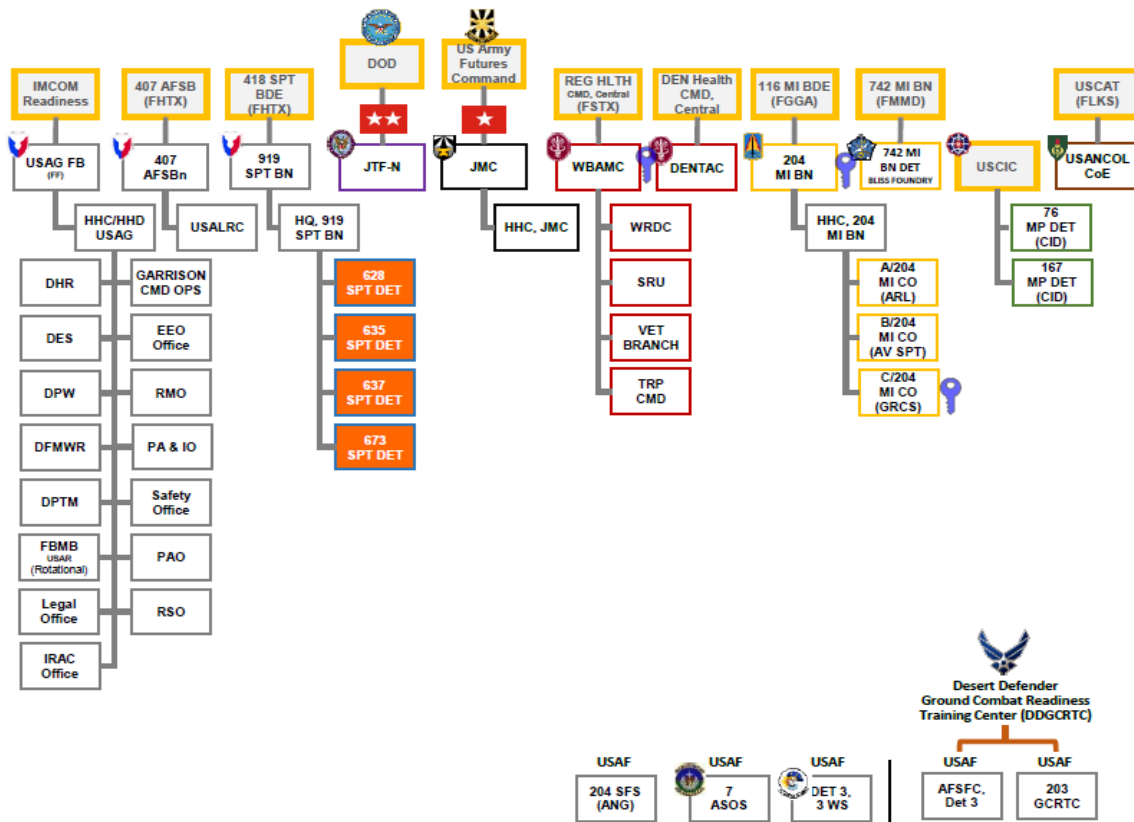
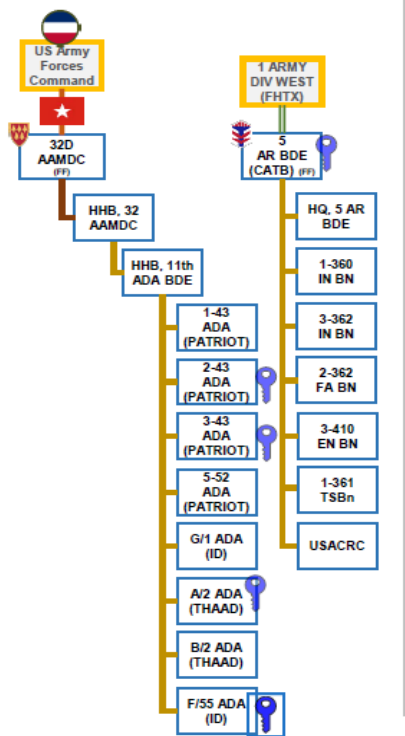

Reserve/Guard and other branches are encouraged to have BOSS Representatives as well





Better Opportunities for Single Soldiers

BOSS BASH 2021 (August 20th @ Biggs Park)

- The date was chosen to allow max participation, prior to 1st BDE's NTC rotation.
- Valuable prizes from sponsors will be given to Soldiers
- Max attendance of Single Soldier population is desired
- We are still in the planning phase for the amenities that will be available BOSS Bash.
- We are open to any support or suggestions for the event.





The Exchange





The Exchange

Door Dash Restaurant Home Delivery

- ✓ Door Dash is now available for Ft. Bliss Residents
- ✓ Participating Restaurants are Popeye's, Burger King, Taco Bell, Charley's, Arby's and Subway
- ✓ Go to <https://www.doordash.com> or download the app today

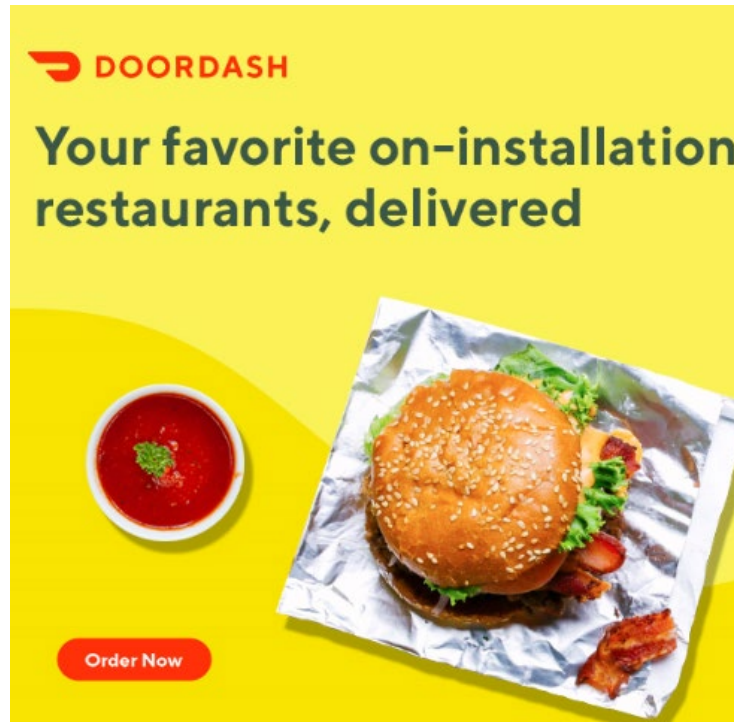



BBC





BBC

BBC – Reminders !

- ✓ **New Landscaping Company – GMI**
 - Same schedule
- ✓ **Trash Pick Up Holiday Schedule**
 - Trash will be picked up on Monday, July 5th
- ✓ **Garage Sales – Allowed**
 - Must fill out form and get approved
- ✓ **RVs and Trailers**
 - Not allowed to be parked at the home
 - 1 day before and 1 day after
- ✓ **Pools**
 - Be considerate
 - 100% open
 - Must be a resident





Freedom Crossing





Freedom Crossing

General Updates

- ✓ Freedom Crossing is now operating at 100% capacity.
- ✓ There is no longer a limit as to how many people can be seated per table.
- ✓ Masks are still required at the Exchange and the Commissary.
- ✓ The Children's Playground is now open!





Freedom Crossing

The Grand Theatre

- ✓ Take advantage of this summer promotion from The Grand Theatre!
- ✓ Every Tuesday and Wednesday at 10 AM.
- ✓ \$4 includes admission, (children, adults, and seniors) popcorn, and soda.
- ✓ Visit our website for more information on their hours of operation.

SUMMER KIDS' FLICKS

ONLY \$4 INCLUDES A FREE BOX OF POPCORN & KID'S SODA!

TUESDAYS & WEDNESDAYS AT 10AM

 <p>PG SHREK JUNE 8 & 9</p>	 <p>PG Trolls World Tour JUNE 15 & 16</p>
 <p>PG KUNG FU PANDA JUNE 22 & 23</p>	 <p>PG SONIC THE HEDGEHOG JUNE 29 & 30</p>
 <p>PG THE CROODS A NEW AGE JULY 6 & 7</p>	 <p>PG ABOMINABLE JULY 13 & 14</p>
 <p>PG MADAGASCAR JULY 20 & 21</p>	 <p>PG DOLITTLE JULY 27 & 28</p>

The Grand 10 | 1619 Pleasonton Road | Fort Bliss, TX 79906 | 915-615-0621

THEGRANDTHEATRE.COM/SKF

BOX OFFICE OPENS AT 9:30 A.M. | MOVIE BEGINS AT 10 A.M.





Freedom Crossing

We're Hiring!

- ✓ Please visit our Facebook page for the latest updates on who's hiring at Freedom Crossing.
- ✓ Blaze Pizza, Buffalo Wild Wings, and Smashburger: <https://phasenexthospitality.com/employment/>
- ✓ Chili's: Email chilis@ARDLLC.net
- ✓ Chipotle: Text CHIPJOBS2601 to 97211
- ✓ Denny's: <https://www.wksusa.com/careers/>
- ✓ Muscle Maker Grill: <https://musclemakergrill.com/contact/careers/restaurants-jobs/#job-listing>
- ✓ Pho Hoa: <https://phohoa.com/jobs/>
- ✓ R&R Nail Spa: Call (915) 307-5041
- ✓ Texas Roadhouse: Call (915) 504-6895





June-August

CUI



Senior Leader attendance
Garrison Event
MWR Event

	01-05	06-12	13-19	20-26	27-31
June	<i>SISD Summer Break June 03-Aug 02</i>				
	<i>YISD Summer Break June 11-August 02</i>				
	<i>EPISD Summer Break June 15-August 02</i>				
				Senior Leader Update 22 Jun, 1100-1200, Centennial Aquapalooza, Biggs Park, 26 June, 1000-1600	
July	<i>EPISD Summer Break ends August 02</i>				
	<i>YISD Summer Break ends August 02</i>				
	<i>SISD Summer Break ends Aug 02</i>				
	Independence Day Salute to the Union, 4 Jul, 1200, Memorial Circle Pop Goes the Fort, Biggs Park, 4 July, 1600			Senior Leader Update 20 Jul, 1100-1200, Centennial Lucha Libre Wrestling 23 Jul, 1800, Location TBD Fort Bliss Community Celebration 23 Jul, 1100-1500, Biggs Park	July Retirement Ceremony 28 Jul, 0900, Soldier Hall, Bldg 2
August			Cardboard Regatta 14 Aug, 1300-1500, Community Pool Senior Leader Update 17 Aug, 1100-1200, Centennial	August Retirement Ceremony 25 Aug, 0900, Soldier Hall, Bldg 2	





SLU POCs

- **RSQ:CH** (MAJ-P) Simon Chang,
915-568-5106
- **Freedom Crossing**: Giovanni Silva
915-564-5311
- **DES**: Mr. Ronnie Ransbottom,
915-744-9143
- **FMWR-FB events**: Michele Wiernicki,
915-568-2554
- **DECA**: Vickie Mills
915-568-9897
- **AAFES**: Mr. Michael Brennan,
915-562-8851 ext. 107
- **WBAMC**: Rajinder Sumair,
915-742-5004
- **DENTAC**: COL Jay Owens,
915.742.6001
- **FMWR-ACS**: Ms. Nancy Thomas-Mainor,
915-569-7758
- **FBSA**: Dania Bandas,
president@thefbsa.org
- **BOSS**: SGT Cherryholmes,
915-892-5195
- **USO**: Ms. Yolanda Castillo,
915-744-3480
- **Volunteer Office**: Ms. Tephanie Hopper,
915-569-7733
- **MWR-SLO**: Simone Wendlant-
Hendricks
915-568-2784
- **DPW Housing**: Ms. Yolanda Brown,
915-568-5309
- **BBC**: Ms. Jessica Holston,
915-496-2401
- **ASYMCA**: Mr. George Elsaesser,
915-263-7164
- **DHR- ACES**:
915-568-6682
- **DHR- SFL/TAP**: Mr. Douglas Piltz,
915-568-7165
- **DHR-ASAP**: Mr. Robert Guile,
915-744-5148

